

Driving Industrial Sustainability

Delivering Value in Fluid-Flow Processes

Southwest IDEAS Conference— November 18, 2021

Joshua Ballard, CFO

FORWARD LOOKING STATEMENT

This presentation contains forward-looking statements within the “Safe Harbor” provisions of the Private Securities Litigation Reform Act of 1995. Forward-looking statements in this report include, but are not limited to, statements about our expectations, objectives, anticipations, plans, hopes, beliefs, intentions, or strategies regarding the future. Forward-looking statements that represent our current expectations about future events are based on assumptions and involve risks and uncertainties. If the risks or uncertainties occur or the assumptions prove incorrect, then our results may differ materially from those set forth or implied by the forward-looking statements. Our forward-looking statements are not guarantees of future performance or events. Words such as “expects,” “anticipates,” “believes,” “estimates,” variations of such words, and similar expressions are also intended to identify such forward-looking statements.

These forward-looking statements are subject to risks, uncertainties, and assumptions that are difficult to predict; therefore, actual results may differ materially and adversely from those expressed in any forward-looking statements. You should not place undue reliance on these forward-looking statements, which reflect management’s opinions only as of the date of this presentation. All forward-looking statements included in this presentation are subject to certain risks and uncertainties, which could cause actual results to differ materially from those projected in the forward-looking statements, as disclosed from time to time in our reports on Forms 10-K, 10-Q, and 8-K as well as in our Annual Reports to Stockholders and, if necessary, updated in our quarterly reports on Form 10 Q or in other filings. We assume no obligation to update any such forward-looking statements. It is important to note that our actual results could differ materially from the results set forth or implied by our forward-looking statements.

Energy Recovery has shown fundamental strength in recent years

Rapid Growth

21% Avg. Product Revenue Growth, 2015-2020

High Margin

68% 2021 Estimated Gross Margin

Strong Balance Sheet

\$108M Cash & Securities and
No Debt

Growing Profitability

21% Increase in EBITDA margin since 2018¹

¹ EBITDA margin excludes GAAP recognized license and development revenue (based on product revenue only)

3.5X SHARE PRICE GROWTH SINCE 2018 – NEARLY 2X THE RUSSELL 2000

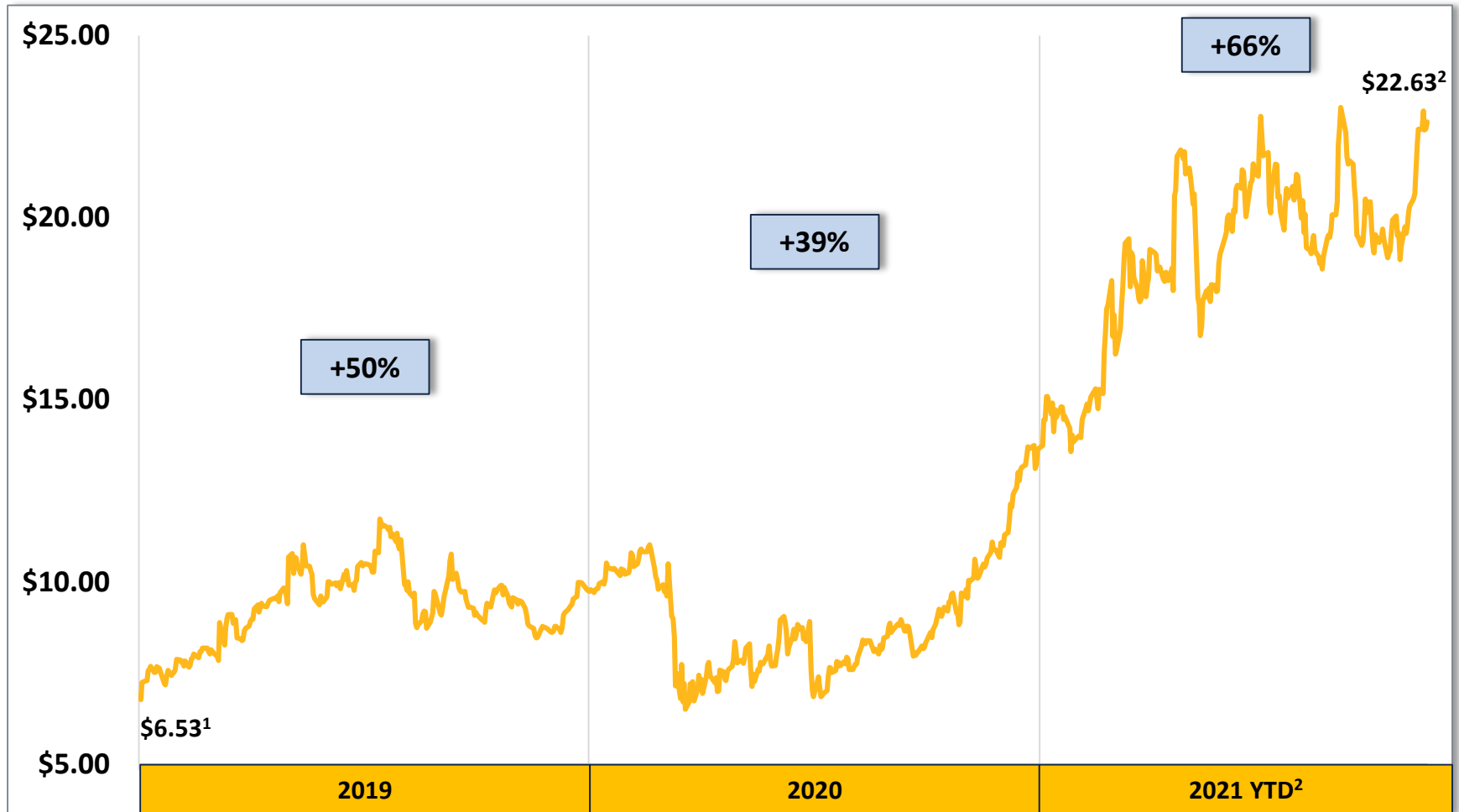

¹ As of December 28, 2018;

² As of November 12, 2021

WE HAVE A STRONG AND GROWING ESG STORY

\$2.6B saved for customers on energy expenses annually¹

12.5M metric tons emissions avoided due to PXs – nearly 3M vehicles removed from the road annually¹

90%+ product revenue from energy-efficiency related products

96% PXs use components made from recycled materials



To download the full report, please visit [bit.ly/ERII ESG 2020](https://bit.ly/ERII_ESG_2020)

Awards & Recognition



¹Energy Recovery estimates. Assumes all deployed devices are in operation

PRESSURE EXCHANGER TECHNOLOGY PLATFORM

- Best-in-class energy recovery
- The PX = unbeatably low life-cycle costs
- Our pressure exchanger technology works as a platform to build product applications
- The technology is versatile – can handle liquid, gas, and a range of pressures
- Benefits include lower lifecycle cost and energy use in industrial fluid-flow systems

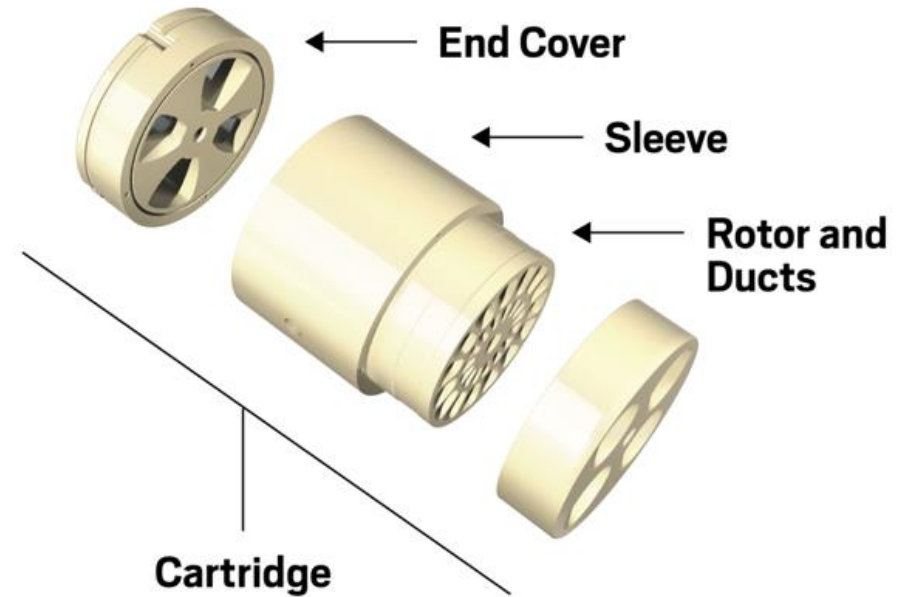

Anatomy of a Pressure Exchanger

Transfers energy from high-pressure to low-pressure fluids (both liquids and gas) through continuously rotating ducts with only one moving part (the rotor).

WHAT IS ENERGY RECOVERY TRYING TO ACHIEVE?



We seek to accelerate the environmental sustainability of our customers' operations



Our solutions reduce waste and energy consumption in industrial fluid-flow systems



We revolutionized seawater reverse osmosis desalination (SWRO), reducing energy costs by up to 60%¹

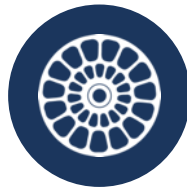

We are expanding our pressure exchanger technology to handle commercial applications in other industries

¹Energy Recovery estimate

3 strategic pillars for long-term sustainable growth and value

THREE STRATEGIC PILLARS

PILLAR 1	PILLAR 2	PILLAR 3
DIVERSIFIED REVENUE GROWTH	INCREASE BOTTOM LINE	ESG
<p>Protect position in SWRO by improving products and operations in a fast-growing market</p> <p>Diversify from desalination and accelerate growth while de-risking revenue</p>	<p>Maintain high margin story By creating customer value via PX platform technology</p> <p>Grow EBITDA margin via focused financial discipline</p>	<p>Accelerate environmental sustainability for customers via reduced energy consumption</p> <p>Align organizational aspirations with sustainable product aspirations</p>

PX TECHNOLOGY PLATFORM – EXCELLING IN A WIDE-RANGE OF PRESSURE APPLICATIONS

- The Pressure exchanger is Energy Recovery's core technology. This versatile technology acts as a fluid piston, efficiently transferring energy between high- and low-pressure fluids and gases through continuously rotating ducts

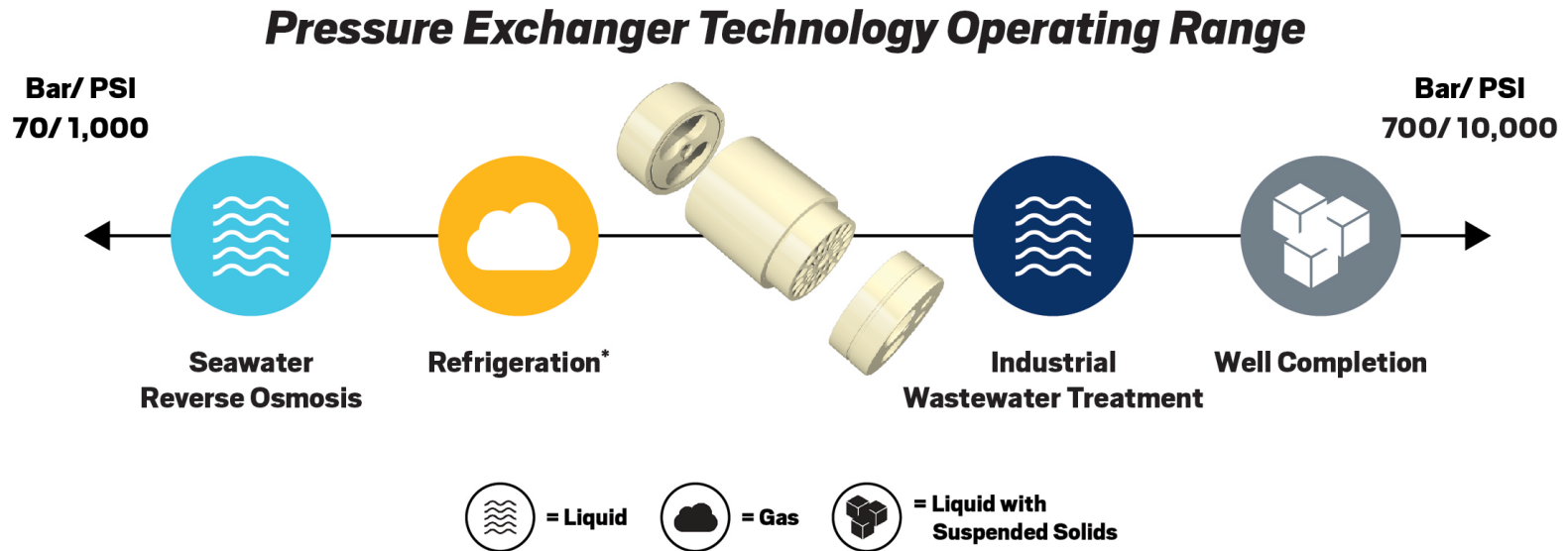

**Pressure Exchanger in refrigeration can handle multiple phases of CO₂ (liquid, gas, and supercritical fluids)*

PRESSURE EXCHANGER TECHNOLOGY IN SWRO

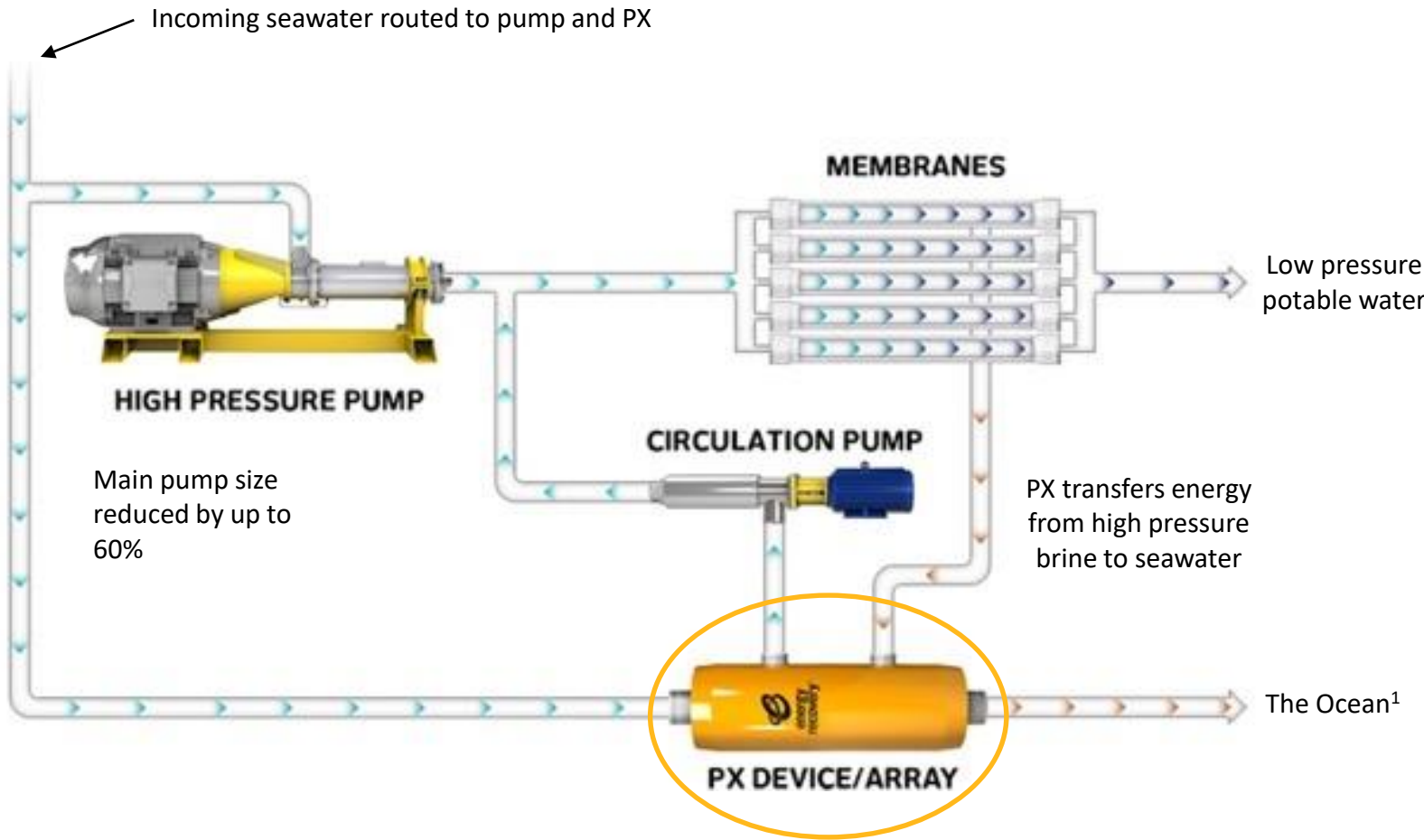

Main pump size reduced by up to 60%

PX transfers energy from high pressure brine to seawater

PX lowers energy consumption by up to 60%



Reverse Osmosis Desalination



Industrial Wastewater Treatment



CO2 Refrigeration



The United Nations estimates a 40% gap in freshwater supplies by 2030 – equivalent to 75% of the Mediterranean Sea



Water Stress by Country: 2040

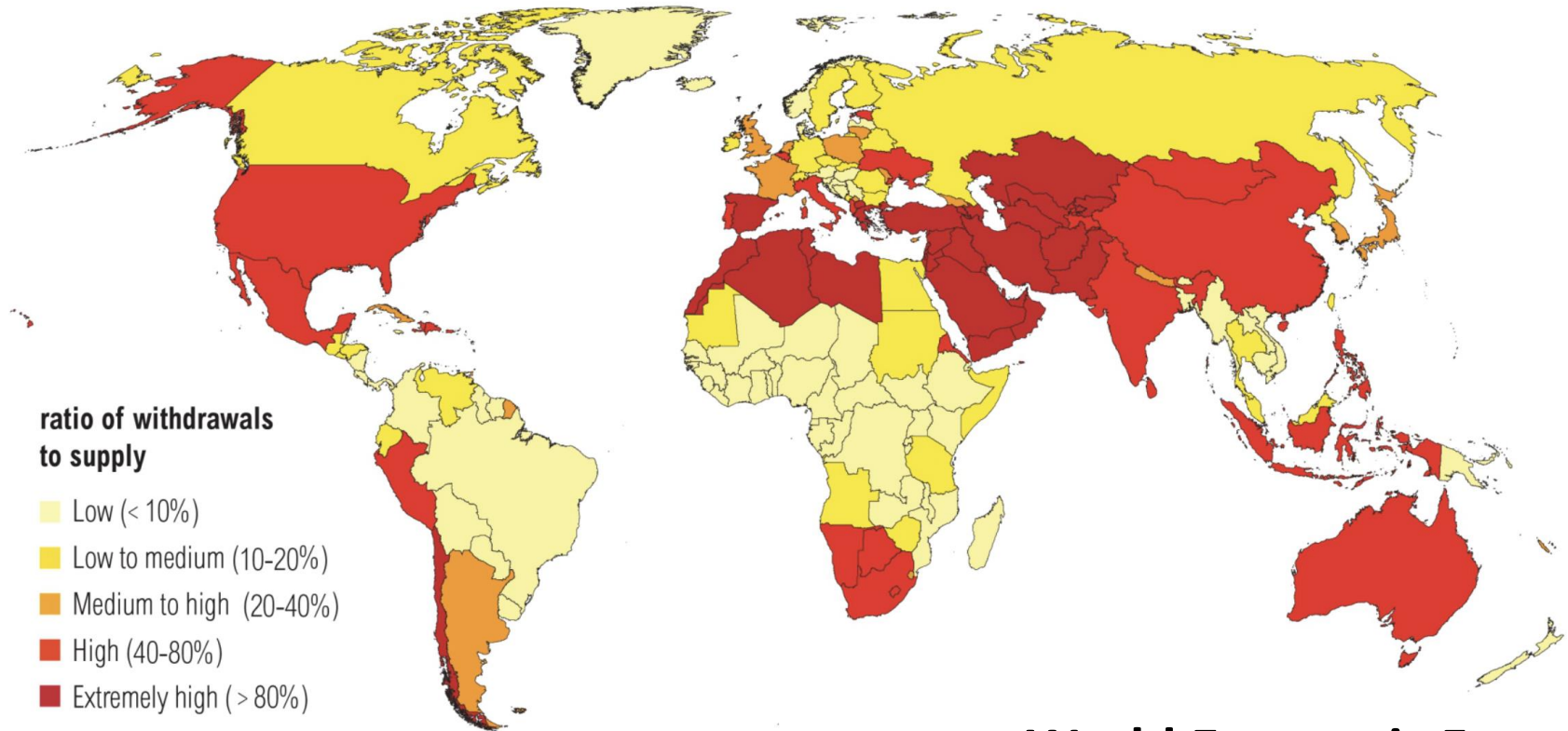

World Economic Forum

NOTE: Projections are based on a business-as-usual scenario using SSP2 and RCP8.5.

FINANCIAL TIMES

No end to crisis in sight as drought grips India's Chennai



Saudi Water Partnership Company has released its Seven-Year Statement for 2020-26

The Washington Post

Africa's largest dam powers dreams of prosperity in Ethiopia – and fears of hunger in Egypt



Australia prepares for 'Day Zero' – the day the water runs out

The New York Times

Flash Drought in the South Brings Record Heat Without Rain



South America ravaged by unprecedented drought and fires



Alaska Villages Run Dry and Residents Worry About a 'Future of No Water'



Reverse Osmosis Desalination

Addressable Market

- Expect to double sales to ~\$200M by 2026¹
- 10-20% projected avg. annual market growth through 2030¹

Market Drivers

- Freshwater scarcity/declining resources
- Water-stressed regions
- Rising population
- Abundance of seawater

Geopolitical Drivers

- Countries turning to SWRO to bridge gap
- 2B+ lack access to clean drinking water
- Trans-boundary water-supply issues



Industrial Wastewater

Addressable Market

- ~\$1B with potential to triple by 2030¹
- Dependent on regulation to realize full TAM

Market Drivers

- Freshwater scarcity/declining resources
- Rising focus on water quality
- Industrialization and urbanization

Geopolitical Drivers

- Countries beginning to require reuse standards
- U.N. goal to triple amount of treated wastewater globally by 2030

OUR PX PLATFORM HAS COME TO DOMINATE LARGE SCALE SWRO DESALINATION

Cumulative Won Mega Project¹ Desal Capacity (m³/day)

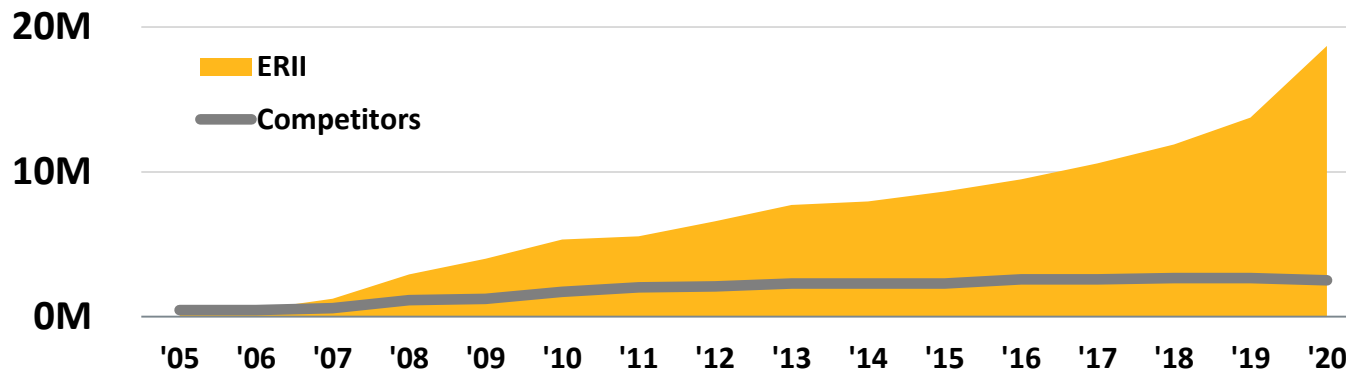

Technology Strength = High Margin

68% ERII Gross Margin²

25% Russell 2000 Industrials

Our ceramics PX Pressure Exchanger is designed for a 25-year life, needs no maintenance and has up to 98% efficiency – unrivalled quality that translates into high profitability

¹ Mega Projects produce 50,000 cubic meters or more of water per day; ²YTD 2021 Reported Gross Margin



CO2 Refrigeration

Regulation is forcing a global transition to natural refrigerants such as CO₂ due to global warming potential (GWP¹) of existing refrigerants

Hydrofluorocarbons ***1,000 - 13,000 GWP***

CO₂ ***1 GWP***

(GWP) Global Warming Potential describes the relative potency of a greenhouse gas, which takes into account how long it remains in the atmosphere and calculated over 100 years. E.g. CO₂ has a 100-year GWP of 1.

~\$1B annual TAM for ERI by 2030¹

¹Energy Recovery projections and estimates based on currently available information. Actual results and figures may differ.

CO₂ systems drive up operating costs to owners via higher energy consumption

Our PX G1300 reduces energy consumption in CO₂ systems by recycling pressure energy during operations, much as in desalination

Signed first contract in November 2021 for delivery in Q1 2022



PRESSURE EXCHANGER TECHNOLOGY IN REFRIGERATION

PX G1300 for CO₂ Refrigeration

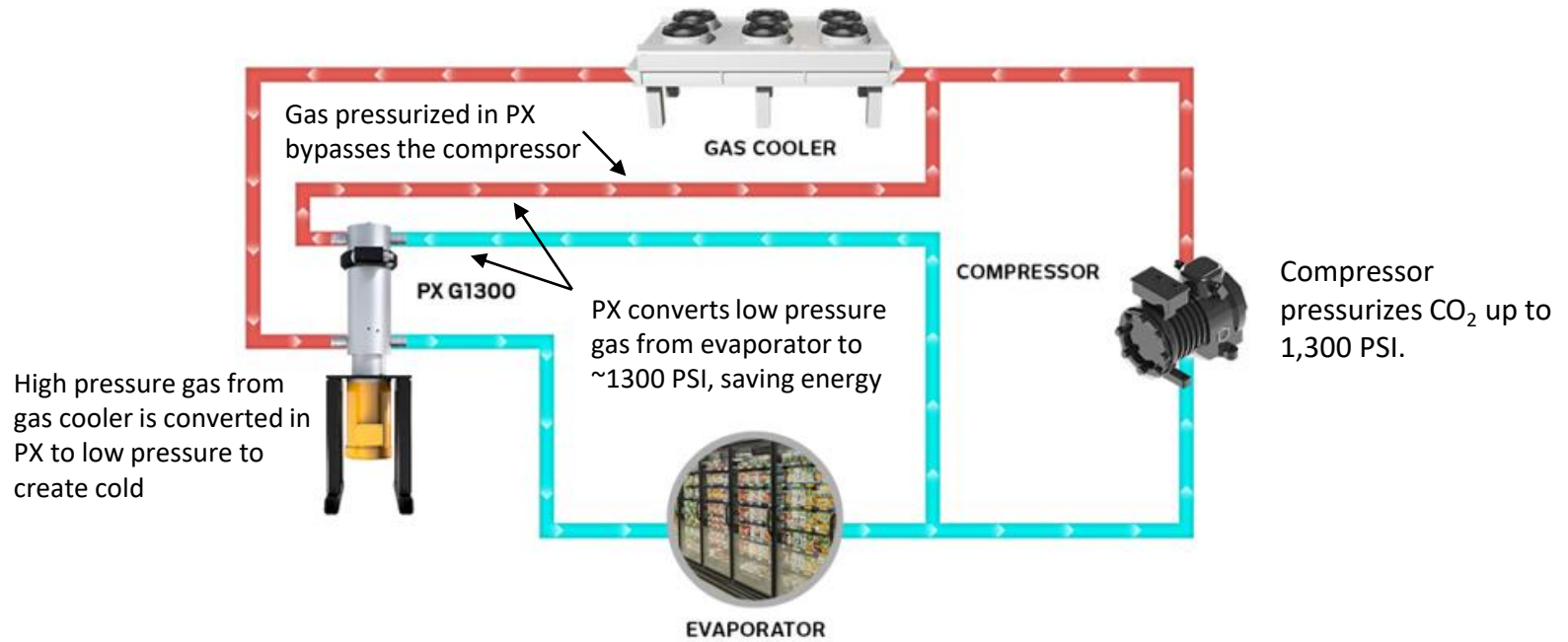

We have expanded the aperture of the PX technology to successfully compress gas, allowing for efficient energy transfer in refrigeration



Our Goal is to Achieve Long-Term and Sustainable Growth by Accelerating the Sustainability of our Customers' Operations

TARGETING 25% - 40% AVG. REVENUE GROWTH THROUGH 2026

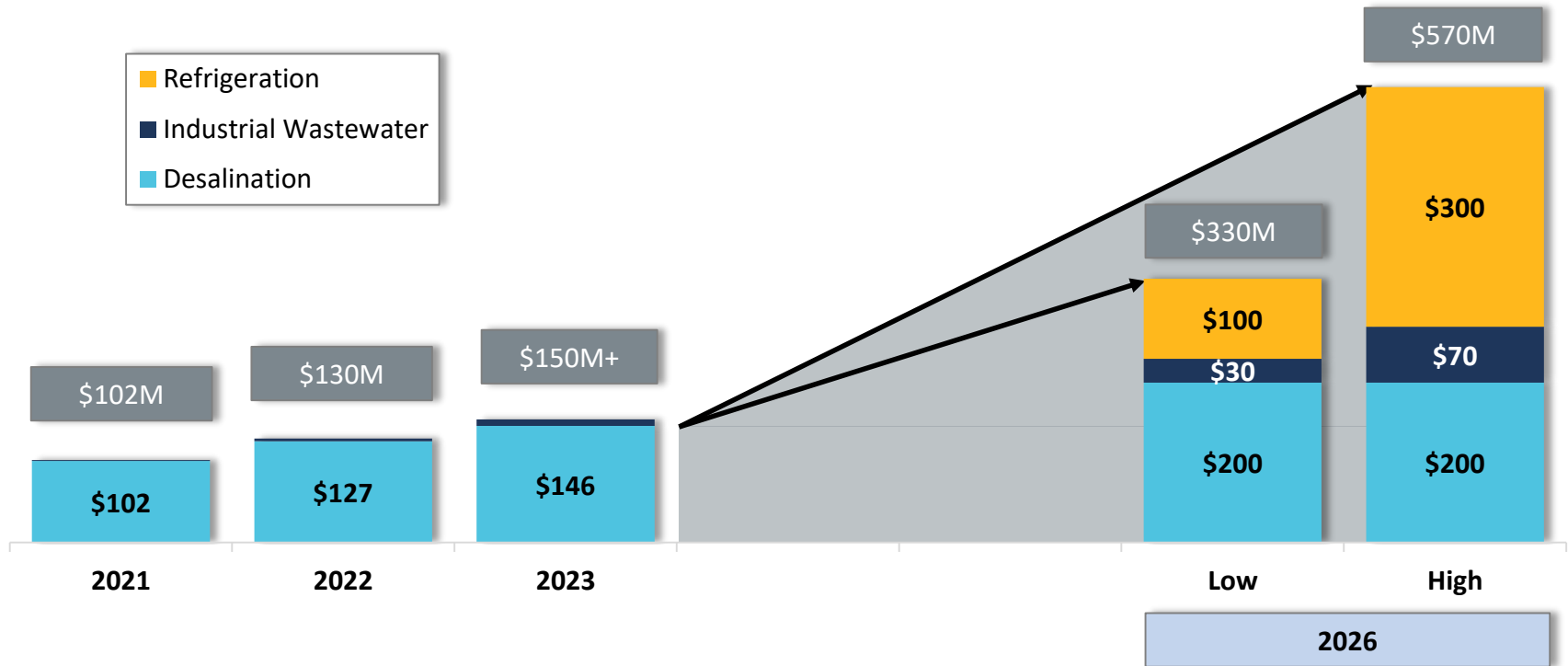

Note: These revenue growth range goals, long-term vision and similar statements illustrate possible outcomes of our different segment strategies. These growth illustrations should not be treated as forecasts, projections or financial guidance. We cannot assure that we will be able to accomplish these goals, metrics or opportunities in the future, all of which are subject to significant risks and uncertainties as set forth under Risk Factors in our Annual Report on Form 10-K.

MAINTAIN GROSS MARGIN AND MANAGE OPEX TO GROW EBITDA

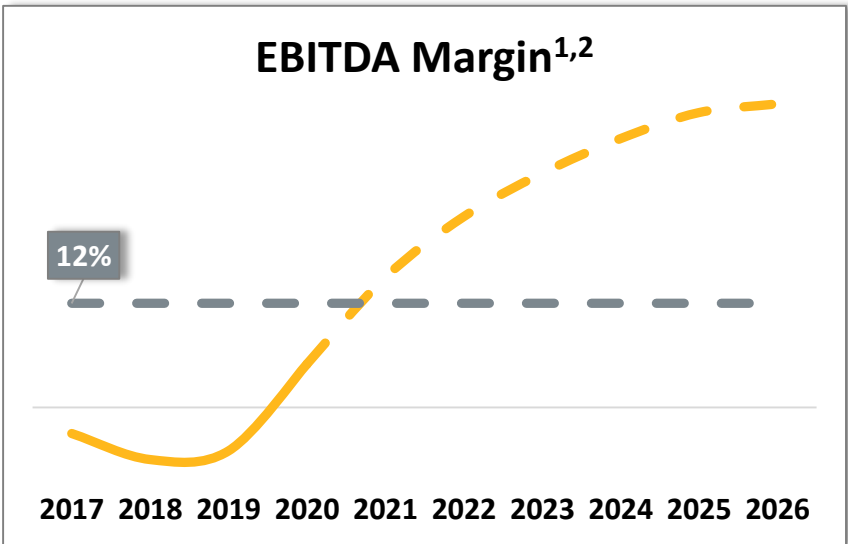
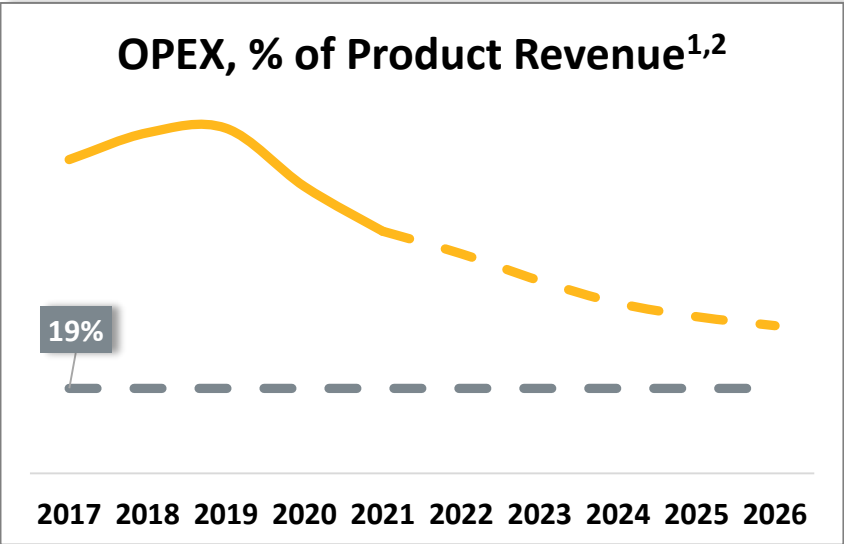

¹2021 – 2026 are estimated projections; ²Excluding Schlumberger License and Development Revenue

Thank You



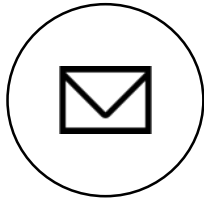

James Siccardi, VP, Investor Relations

+1.832.474.7628 | Mobile

jsiccardi@energyrecovery.com

Lionel McBee, Sr. Mgr., Investor Relations

+1.832.334.3685 | Mobile

limcbee@energyrecovery.com

ESG@energyrecovery.com

(for ESG inquiries)



Energy Recovery, Inc.

1717 Doolittle Drive

San Leandro, CA 94577, USA

energyrecovery.com